

No Name Konstruktion®

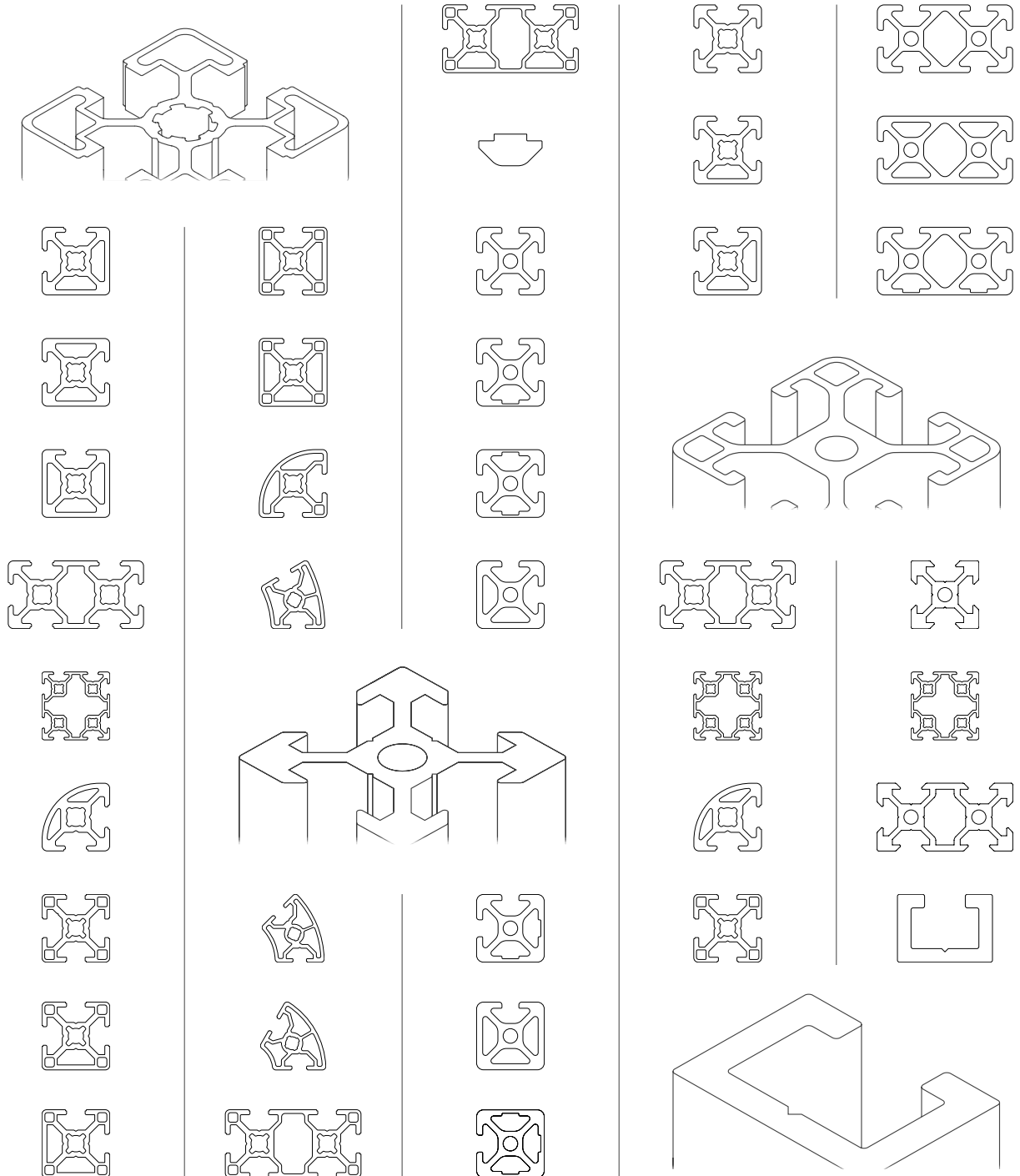

ARBEITSKARTEN

BSP / ISP / CSP / VSP





No Name Konstruktion®

ARBEITSKARTE
BSP-SYSTEM

Bosch kompatibel

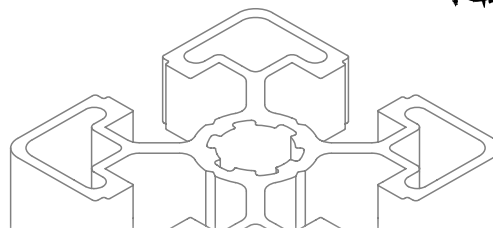

BSP ROHRSYSTEM

















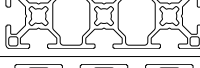

N	R	A	Typ	Abmessung B x H mm	Querschnitt	IX mm ⁴	IY mm ⁴	WX max WX min mm ³	WY max WY min mm ³	Gewicht kg/m
-	-	L	D28	∅ 28		16168,00	16168,00	1156,20 1156,20	1156,20 1156,20	±0,725
-	-		D28P	∅ 28		13880,00	13906,00	1037,60 1035,40	1038,50 1038,50	±0,507
10	-		D28N10	∅ 28		10030,00	19652,00	887,60 869,30	1403,70 1403,70	±0,702

BSP 6



6	20	L	L20	20x20		6688,10	6688,10	668,80 668,80	668,80 668,80	±0,439
			L21	20x20 1N		7515,60	6742,70	793,10 714,10	674,30 674,30	±0,473
			L23	20x20 2N-90°		7597,00	7597,00	798,60 724,50	798,60 724,50	±0,497
			L24	20x20 2N-180°		8412,90	6778,10	841,30 841,30	677,80 677,80	±0,499
			L25	20x20 3N		7590,00	8432,00	795,90 725,50	843,20 843,20	±0,525
			L41	20x40		45789,20	11875,00	2289,50 2289,50	1187,50 1187,50	±0,773
			L40	40x40		81629,00	81629,00	4081,40 4081,40	4081,40 4081,40	±1,265
			L22	20x20 R17		5779,90	5779,90	545,80 614,20	545,80 614,20	±0,437













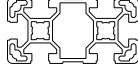
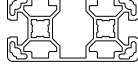

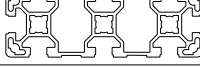



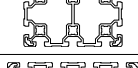
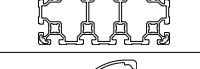

BSP 8

8	Z	NAD	9x4		23,00	114,00	6,20 5,90	24,80 24,80	±0,035
	30	L	L30 */**	30x30		26803,90	26803,90	1787,00 1787,00	1787,00 1787,00









N	R	A	Typ	Abmessung B x H mm	Querschnitt	IX mm ⁴	IY mm ⁴	WX max WX min mm ³	WY max WY min mm ³	Gewicht kg/m
8	30	L	L31 */**	30x30 1N		32468,60	29148,20	2279,70 2060,50	1943,20 1943,20	±0,932
			L33 */**	30x30 2N-90°		32734,90	31163,20	2082,60 2292,10	2185,20 1979,90	±0,982
			L34 */**	30x30 2N-180°		36297,00	29261,80	2419,80 2419,80	1950,80 1950,80	±0,982
			L35 */**	30x30 3N		31153,00	34812,00	2178,40 1984,20	2320,20 2320,20	±0,997
			L32 */**	30x30 R25		22682,80	22682,80	1637,40 1404,70	1404,70 1637,40	±0,776
			L330	38x30 30/30°		34895,00	35975,00	2464,80 2056,60	1897,90 1897,90	±0,985
			L345	44,7x30 30/45°		37789,00	54855,00	2123,00 1880,80	2276,10 2168,10	±1,144
			L360	43,5x30 30/60°		41226,00	30624,00	1895,90 1895,90	2234,90 1732,40	±0,978
			L61 */**	60x30		195063,40	50342,50	6502,10 6502,10	3356,20 3356,20	±1,489
			L63 *	60x30 2N		201861,00	55969,00	6728,70 6728,70	3926,50 3554,50	±1,579
			L91 *	90x30		610831,00	73051,00	13574,00 13574,00	4870,10 4870,10	±2,146
			L121 *	120x30		1382982,00	96725,00	23049,70 23049,70	6448,30 6448,30	±2,812
			L60 *	60x60		370420,00	370420,00	12347,30 12347,30	12347,30 12347,30	±2,580
			L65 *	60x60x30		261167,00	261213,00	7528,60 7528,80	7529,90 7529,90	±2,255
			SP120	120x15		1087857,00	21520,00	18131,00 18131,00	2732,40 3020,70	±2,421
			L22	20x11		5157,00	1302,00	515,70 515,70	292,00 199,20	±0,275
			30WG40 *	30x30 WG40		29028,10	25004,70	1815,30 1815,30	1582,80 1582,80	±0,863
			30WG40 Typ B **	30x30 WG40		30511,00	25236,00	2136,60 1941,00	1762,40 1609,30	±0,865
			45WG40 *	30x45 WG40		40543,00	69448,80	2512,80 2512,80	3086,60 3086,60	±1,200

BSP 10

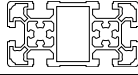
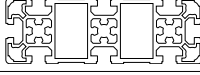
10	40	L	Z	NAD	11,4x6,8		62,00	293,00	11,80 11,50	51,40 51,40	±0,056
			L40	40x40		90360,00	90360,00	4518,00 4518,00	4518,00 4518,00	±1,502	
			L41	40x40 1N		96631,70	90051,00	4693,50 4693,50	4527,50 4527,50	±1,549	

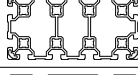
N	R	A	Typ	Abmessung B x H mm	Querschnitt	IX mm ⁴	IY mm ⁴	WX max WX min mm ³	WY max WY min mm ³	Gewicht kg/m			
10	40	L	L42	40x40 2N-90°		96834,40	96834,40	4983,30 4707,40	4983,30 4707,40	±1,596			
			L43	40x40 2N-180°		90747,80	103304,80	4537,40 4537,40	5165,20 5165,20	±1,596			
			L453	40x40 3N		103501,60	97036,80	5175,00 5175,00	4721,00 4721,00	±1,644			
			L81	80x40		626328,00	171916,00	15658,20 15658,20	8595,80 8595,80	±2,635			
			L83	80x40 2N		642206,00	186288,00	16055,10 16055,10	9724,10 8937,90	±2,727			
			L84	80x40 3N-90°		715261,00	198876,00	18295,70 17274,60	10316,70 9370,80	±2,971			
			L121	120x40		1934467,00	252733,00	32241,10 32241,10	12636,70 12636,70	±3,759			
			L161	160x40		4606747,00	368960,00	57584,30 57584,30	18448,00 18448,00	±5,444			
			L80	80x80		1314127,00	1314127,00	32853,20 32853,20	32853,20 32853,20	±4,898			
			L86	80x80 2N		1332190,00	1353946,00	33304,80 33304,80	34295,20 33413,60	±4,958			
			L87	80x80 4N-90°		1372015,00	1372015,00	34747,40 33864,70	34747,40 33864,70	±5,019			
			L122	120x80		3530841,00	1759896,00	58847,30 58847,30	43997,40 43997,40	±6,385			
			L162	160x80		7754068,00	2327167,00	96925,90 96925,90	58179,20 58179,20	±8,270			
			L44	40x40 R33,3		69396,30	69396,30	3896,50 3127,40	3127,40 2873,30	±1,313			
			L85	80x80x40		823019,00	823024,00	24151,20 17922,20	24150,90 17922,20	±3,781			
			45			L45	45x45		109971,00	109971,00	4887,60 4887,60	4887,60 4887,60	±1,551
						L46	45x45 1N		120793,70	117762,20	5405,10 5332,60	5233,80 5233,80	±1,638
						L46 Typ A	45x45 1N		110002,00	117845,00	4889,00 4889,00	5090,40 5090,40	±1,596
	L47	45x45 2N-90°					120962,10	120553,60	5411,80 5340,80	5333,00 5383,10	±1,638		
	L47 Typ A	45x45 2N-90°					118051,00	118051,00	5397,30 5104,20	5397,30 5104,20	±1,644		
	L48	45x45 2N-180°					115639,30	122697,10	5139,50 5139,50	5453,20 5453,20	±1,611		
	L48 Typ A	45x45 2N-180°					110200,00	126379,00	4897,80 4897,80	5616,90 5616,90	±1,644		
	L49	45x45 3N					121304,00	124318,00	5426,90 5356,20	5525,20 5525,20	±1,642		
	L49 Typ A	45x45 3N					118256,00	126578,00	5402,30 5117,00	5625,70 5625,70	±1,246		

N	R	A	Typ	Abmessung B x H mm	Querschnitt	IX mm ⁴	IY mm ⁴	WX max WX min mm ³	WY max WY min mm ³	Gewicht kg/m
10	45	L	L495 Typ A	45x45 4N		126776,00	126776,00	5634,50 5634,50	5634,50 5634,50	±1,739
			L4530	45x30		38486,00	81216,00	2647,00 2489,30	3609,60 3609,60	±1,064
			L451	45x45 R37,5		80838,00	80838,00	4024,90 3244,50	3244,50 4024,90	±1,297
			L430	57x45 45/30°		151452,00	125541,00	5326,80 5326,80	5879,70 4958,90	±1,857
			L445	67x45 45/45°		135335,00	214703,00	6156,30 5810,30	6408,60 6408,60	±2,046
			L91	90x45		821520,00	235902,00	18256,00 18256,00	10484,50 10484,50	±3,069
			L92	90x45 1N		85411,60	235794,30	10480,60 10478,80	19274,80 18694,70	±3,114
			L94	90x45 2N		838344,00	251805,00	18634,50 18625,20	11526,60 10875,00	±3,161
			L95	90x45 4N-180°		856463,00	269011,00	19037,10 19027,90	11956,90 11955,10	±3,256
			L96	90x45 3N-90°		872250,00	252009,00	19675,00 19100,10	11530,80 10888,40	±3,209
			L90	90x90		2128688,70	2128688,70	47304,20 47304,20	47304,20 47304,20	±6,420
			L97	90x90 2N		2173964,00	2146153,00	48793,50 47836,60	47692,30 47692,30	±6,474
			L93	90x90 4N-90°		2216076,30	2216076,30	50163,10 48362,00	48362,00 46560,90	±6,606
			L181	180x90		13832113,00	4000684,00	153690,20 153690,20	88904,10 88904,10	±11,438
			L22	22,5x15		8156,00	3414,00	725,00 725,00	502,10 416,40	±0,335
			L23	45x22,5		29860,60	71938,30	2654,30 2654,30	3197,30 3197,30	±1,324
		UL	UL91	90x45		772906,00	189589,00	17178,80 17175,60	8427,10 8425,30	±2,521
		S	S45	45x45		134572,00	134572,00	5981,00 5981,00	5981,00 5981,00	±1,968
			S91	90x45		1250353,00	323570,00	27785,60 27785,60	14380,90 14380,90	±4,179
			S182	180x45		7482483,00	568981,00	83138,70 83138,70	25288,00 25288,00	±6,869
			S90	90x90		2995140,00	2995140,00	66558,60 66558,60	66558,60 66558,60	±10,342
			S181	180x90		21381507,00	5442448,00	237572,00 237572,00	120943,00 120943,00	±17,230
			S61	60x45		229868,80	377225,60	10216,40 10216,40	12574,20 12574,20	±3,013
			S95	90x90x45		1521136,00	1521136,00	39898,40 29323,20	39898,40 29323,20	±5,733

N	R	A	Typ	Abmessung B x H mm	Querschnitt	IX mm ⁴	IY mm ⁴	WX max WX min mm ³	WY max WY min mm ³	Gewicht kg/m	
10	45	S	S96	90x90x45 4N-90°		1629069,00	1629069,00	43661,20 30918,90	43661,30 30918,90	±6,035	
	50	L	L50	50x50		210374,00	210374,00	8414,90 8414,90	8414,90 8414,90	±2,500	
			L101A	100x50		1571183,00	419230,00	31423,70 31423,70	16769,20 16769,20	±4,454	
			L151	150x50		5128543,00	630421,00	68380,60 68380,60	25216,80 25216,80	±6,679	
			L100	100x100		3123632,30	3123632,30	62472,60 62472,60	62472,60 62472,60	±7,967	
			L201	200x100		21249703,00	6011966,00	212497,00 212497,00	120239,30 120239,30	±14,774	
			S	S101	100x50		2200269,00	512755,00	44002,80 44002,80	20509,50 20509,50	±5,737
	60	L	L60	60x60		323586,00	323586,00	10786,20 10786,20	10786,20 10786,20	±2,710	
			S	S60	60x60		527197,00	527197,00	17573,20 17573,20	17573,20 17573,20	±3,883
				S9060	90x60		2119685,00	897444,00	47104,10 47104,10	29921,40 29921,40	±6,865

Legende

N = Nut R = Raster A = Ausführung
 UL = ultraleicht/eco L = leicht M = medium S = schwer Z = Zubehör
 Ix/Iy = Flächenträgheitsmoment * = Kernbohrung 6,8 mm für Gewindeschneiden NAD = Nutabdeckprofil
 Wx/Wy = Widerstandsmoment ** = Kernbohrung 7,3 mm für Spezialverbinder D = Durchmesser

Mechanische Eigenschaften

Bezeichnung	EN 572-3	EN AW-6063
Zustand	EN 515	T66
R _{p0,2}	[N/mm ²]	≥200
R _m	[N/mm ²]	≥245
A	[%]	≥8
A 50	[%]	≥6
Härte	[HB]	≥80

Kernbohrung

Nut 6 = 5,5-0,1/+0,3 mm	Nut 8** = 7,3-0,1/+0,3 mm
Nut 8* = 6,8-0,3/+0,1 mm	Nut 10 = 10,0+/-0,15 mm

Nutmaße

Nut 6 = 6,0+0,4 mm	Nut 8 = 8,0+0,4 mm
Nut 10 = 10,0+0,4 mm	

Oberfläche	Eloxal E6Ev1 (silber) / E6Ev6 (schwarz) Andere Ausführungen auf Anfrage
Länge	6030-0+10 mm Kontaktstellen entfernt/6090-0+10 mm Standardkontaktierung Andere Längen auf Anfrage
Normen	DIN EN 573, 755, Toleranzen DIN EN 12020



No Name Konstruktion®

ARBEITSKARTE





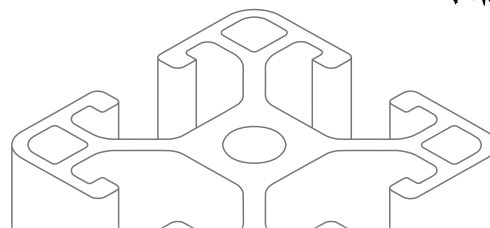





ISP-SYSTEM

item kompatibel























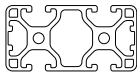
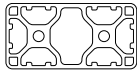
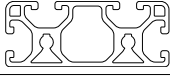





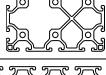
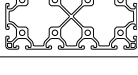



ISP 5



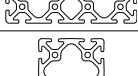

N	R	A	Typ	Abmessung B x H mm	Querschnitt	IX mm ⁴	IY mm ⁴	WX max WX min mm ³	WY max WY min mm ³	Gewicht kg/m
5	20	L	L20	20x20		7479,00	7479,00	747,90 747,90	747,90 747,90	±0,493
			L21	20x20 1N		7861,10	7521,90	801,80 770,90	752,20 752,20	±0,509
			L22	20x20 2N-180°		8224,20	7531,40	822,40 822,40	753,10 753,10	±0,519
			L23	20x20 2N-90°		7869,00	7869,00	802,30 773,00	802,30 773,00	±0,519
			L23A	20x20 2N-90°		7981,00	7981,00	819,40 777,80	819,40 777,80	±0,562
			L24	20x20 3N		8302,00	9091,00	864,70 798,30	909,10 901,10	±0,577
			L24 A	20x20 3N		8475,00	7994,00	847,50 847,50	820,20 779,60	±0,540
			L41	40x20		14010,80	51215,10	1401,10 1401,10	2560,70 2560,70	±0,883
			L42	40x20 4N-180°		15622,00	53303,00	1562,20 1562,20	2665,10 2665,10	±0,940
			L43	40x20 2N		14906,00	52699,00	1523,50 1459,10	2634,90 2634,90	±0,938
			L44	40x20 2N-180°		14229,00	54865,00	1422,90 1422,90	2743,20 2743,20	±0,938
			L47	40x20 3N-90°		15305,00	55547,00	1584,00 1480,50	2826,50 2729,80	±0,954
			L61	60x20		20896,00	162389,50	2089,60 2089,60	5412,90 5412,90	±1,299
			L81	80x20		27627,00	369284,00	2765,10 2760,30	9232,10 9232,10	±1,702
			L40	40x40		93388,40	93388,40	4669,40 4669,40	4669,40 4669,40	±1,394
L64	60x40		136228,00	283373,00	6811,40 6811,40	9753,90 9150,20	±2,088			
L25	20x22 R20/40-30°		4375,00	6848,00	543,30 391,10	692,20 566,90	±0,465			

N	R	A	Typ	Abmessung B x H mm	Querschnitt	IX mm ⁴	IY mm ⁴	WX max WX min mm ³	WY max WY min mm ³	Gewicht kg/m
5	20	L	L26	28x25 R20/40-45°		12712,00	9879,00	1094,90 804,10	828,90 752,80	±0,654
			L27	34x30 R20/40-60°		24334,00	15505,00	1647,20 1274,70	1068,70 1051,00	±0,742
			L28	40x40 R20/40-90°		51882,00	51882,00	2606,00 2589,10	2606,00 2589,10	±1,087
			L29	20x20 R20-90°		5876,00	5876,00	652,30 540,10	652,30 540,10	±0,474
			L18	40x30		61947,00	29468,00	4107,40 2486,00	2093,80 1850,30	±0,841
		S	S24	20x20 R20		6386,20	6386,20	683,70 605,40	683,70 605,40	±0,536
			S28	16x8,5		584,00	2322,00	161,30 119,70	280,10 280,10	±0,224
			S29	20x10		1229,80	5284,00	272,40 224,10	528,40 528,40	±0,352
			S46	40x10		4566,00	36464,00	504,90 456,60	1823,20 1823,20	±0,651
			S86	80x14		11223,00	410902,00	1654,10 1555,50	10272,60 10272,60	±1,816
		Z	NSP	9,5x4,75		48,00	166,00	21,00 19,70	34,90 34,90	±0,089



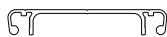







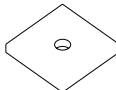
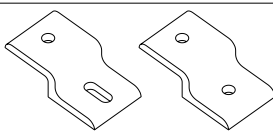
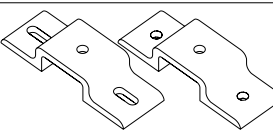

ISP 6





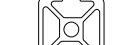











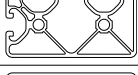







6	30	L	L30	30x30		29499,00	29499,00	1966,60 1966,60	1966,60 1966,60	±0,940
			L31	30x30 1N		29524,00	30876,00	1968,30 1968,30	2021,60 2021,60	±0,958
			L32	30x30 2N-180°		29549,00	32305,00	1969,90 1969,90	2153,70 2153,70	±0,976
			L33	30x30 2N-90°		30901,00	30901,00	2097,60 2023,90	2097,60 2023,90	±0,976
			L36	30x30 3N		30927,00	32330,00	2098,60 2026,20	2155,30 2155,30	±0,994
			L37	30x30 4N		33177,00	32838,00	2221,70 2202,00	2189,20 2189,20	±1,026
			L324	30x24		17148,00	23003,00	1473,40 1387,20	1533,50 1533,50	±0,766
			L61	60x30		56456,00	214983,00	3763,70 3763,70	7166,10 7166,10	±1,679
			L62	60x30 4N-180°		62051,00	221052,00	4136,70 4136,70	7368,40 7368,40	±1,751
			L63	60x30 2N		59195,00	218017,00	4028,00 3867,80	7267,20 7267,20	±1,715
			L66	60x30 3N-90°		59220,00	223738,00	4028,90 3870,30	7534,80 7382,60	±1,733



















N	R	A	Typ	Abmessung B x H mm	Querschnitt	IX mm ⁴	IY mm ⁴	WX max WX min mm ³	WY max WY min mm ³	Gewicht kg/m		
6	30	L	L67	60x30 2N-180°		56505,00	226543,00	3767,00 3767,00	7551,40 7551,40	±1,715		
			L68	60x30 6N		64490,00	240654,00	4299,30 4299,30	8021,80 8021,80	±1,838		
			L624	60x24		32253,00	173476,00	2797,20 2586,50	578,50 578,50	±1,361		
			L121	120x30		110369,00	1545064,00	7357,90 7357,90	25751,00 25751,00	±3,157		
			L60	60x60		399795,00	399795,00	13326,50 13326,50	13326,50 13326,50	±2,739		
			L65	60x60 2N		416153,00	404237,00	14132,30 13620,70	13474,60 13474,60	±2,791		
			L64	60x60 4N-90°		420827,00	420827,00	14288,70 13775,80	14288,70 13775,80	±2,845		
			L69	60x60 8N		442040,00	442040,00	14734,70 14734,70	14734,70 14734,70	±2,95		
			L91	90x30		83092,00	675590,00	5539,50 5539,50	15013,10 15013,10	±2,410		
			L92	90x60		587197,00	1219841,00	19573,20 19573,20	27850,60 26403,20	±4,062		
			L122	120x60		773830,00	2618623,00	25790,70 25790,70	43643,70 43643,70	±5,087		
			L39	30x12		2592,00	14038,00	460,00 407,10	935,90 935,90	±0,42		
			L38	60x12		5570,00	101570,00	1007,20 861,00	3385,70 3385,70	±0,828		
			L330	30x30 R30/60-30°		39386,00	27916,00	2663,20 2456,70	1833,40 1574,20	±0,892		
			L345	41x37 R30/60-45°		54103,00	41618,00	3127,30 2986,80	2289,80 2146,80	±1,234		
			L360	51x44 R30/60-60°		101166,00	63667,00	4602,40 3511,00	2913,90 2888,40	±1,408		
			L390	60x60 R30/60-90°		229072,00	229334,00	7744,00 7550,00	7731,90 7578,70	±2,153		
			L34	30x30 R30		21813,00	21813,00	1629,90 1326,00	1629,90 1326,00	±0,838		
			L35	30x30 G45°		20991,60	20991,60	1593,50 1247,50	1593,50 1247,50	±0,818		
			S	30	S30	30x30		42014,00	42014,00	2800,90 2800,90	2800,90 2800,90	±1,276
			S61		60x30		76738,00	281554,00	5115,90 5115,90	9385,10 9385,10	±2,204	
			S121		120x30		156305,00	2125845,00	10420,30 10420,30	35430,70 35430,70	±4,376	
			S122		120x60		1039131,00	3507748,00	34637,70 34637,70	58462,50 58462,50	±6,78	
			S60		60x60		520223,00	520249,00	17337,90 17337,90	17339,00 17339,00	±3,504	

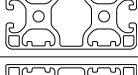
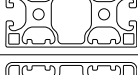
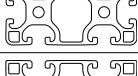
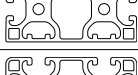
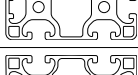

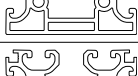
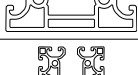



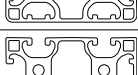

N	R	A	Typ	Abmessung B x H mm	Querschnitt	IX mm ⁴	IY mm ⁴	WX max WX min mm ³	WY max WY min mm ³	Gewicht kg/m
6	30	Z	60D	60x9,5		1161,00	59195,00	407,10 174,70	1973,20 1973,20	±0,374
			6030U	60x27		12803,00	125795,00	1822,90 640,90	4091,60 4091,60	±0,592
			6060U	60x57		104309,00	199703,00	5847,30 2663,60	6494,40 6494,40	±0,820
			NSP	13x8		290,00	691,00	73,10 72,00	106,20 106,20	±0,2

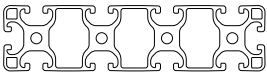
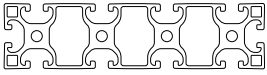
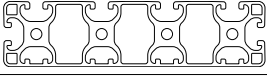
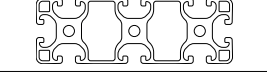

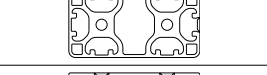

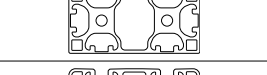
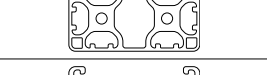
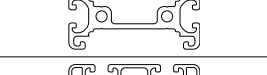
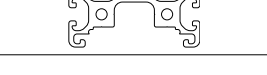
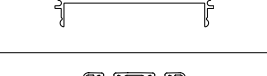
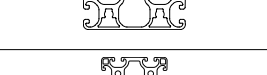
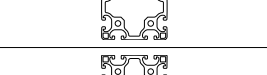
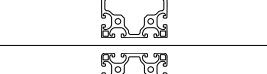
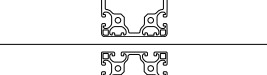
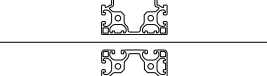
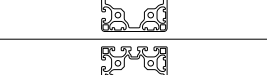
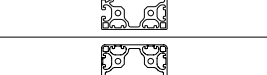
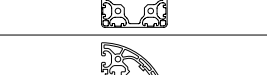

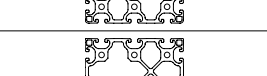



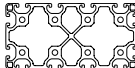
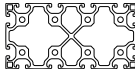
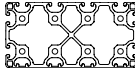









ISP 8



















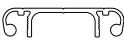

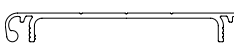

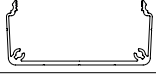
8	Z	Z	NAD	9,2x5		23,00	114,00	6,20 5,90	24,80 24,80	±0,035	
8	30	Z	SEL1816	27,5x18		3686,00	4258,00	289,90 249,40	481,50 465,10	±0,259	
			NSP	16x9,5		683,00	1799,00	152,10 136,50	224,80 224,80	±0,315	
			MP40 R	40x6						±0,647	
			PH40 EL PH40 ER	77x22						±1,470	
			PH40 DL PH40 DR	120,6x22						±2,441	
	L	30	L	L30	30x30		31317,30	31317,30	2087,80 2087,80	2087,80 2087,80	±0,898
				L31	30x30 1N		34352,50	31406,20	2394,40 2194,60	2093,70 2093,70	±0,942
				L32	30x30 2N-90°		34448,10	34448,10	2396,20 2204,80	2204,80 2393,20	±0,986
				L33	30x30 2N-180°		31495,00	37684,00	2099,70 2099,70	2512,30 2512,30	±0,986
				L36	30x30 3N		34543,00	37773,00	2398,40 2214,70	2518,20 2518,20	±1,03
				L61	60x30		64477,60	214062,60	4298,50 4298,50	7135,40 7135,40	±1,838
				L62	60x30 2N		70554,70	221537,10	4912,80 4511,50	7384,60 7384,60	±1,926
				L67	60x30 2N-180°		64738,00	241513,00	4315,90 4315,90	8050,40 8050,40	±1,919
				L60	60x60		438964,00	438964,00	14632,10 14632,10	14632,10 14632,10	±3,643
L34	30x30 R30		25043,10	24704,60	1842,60 1526,30	1828,70 1498,10	±0,839				

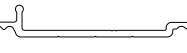

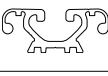













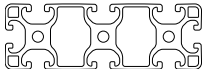

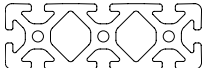
N	R	A	Typ	Abmessung B x H mm	Querschnitt	IX mm ⁴	IY mm ⁴	WX max WX min mm ³	WY max WY min mm ³	Gewicht kg/m
8	40	UL	UL40	40x40		72604,00	72604,00	3630,20 3630,20	3630,20 3630,20	±1,294
			UL40 TypA	40x40		73272,00	73272,00	4798,10 4798,10	3663,60 3663,60	±1,368
			UL42	40x40 2N-180°		81180,00	87582,00	4059,00 4059,00	4379,10 4379,10	±1,349
			UL43	40x40 2N-90°		78139,00	82238,00	4063,20 3762,20	4143,80 4080,60	±1,321
			UL44	40x40		55401,00	55401,00	3620,50 2243,10	3620,50 2243,10	±1,161
			UL81	80x40		149078,00	580780,00	7453,90 7453,90	14519,50 14519,50	±2,388
			UL82	80x40 3N-90°		159187,00	562417,00	7809,30 8115,20	13793,50 14337,90	±2,287
			UL83	80x40 4N-180°		157746,00	563791,00	7887,30 7887,30	14094,80 14094,80	±2,236
			UL85	80x40 2N-180°		159418,00	554037,20	7970,90 7970,90	13850,90 13850,90	±2,300
			UL80	80x80		1022520,70	1022520,70	25563,00 25563,00	25563,00 25563,00	±4,216
			UL84	80x80		510042,00	510042,00	20006,60 9357,50	20006,60 9357,50	±2,438
			UL49	40x16		6755,00	34156,00	868,70 821,40	1707,80 1707,80	±0,625
			UL86	80x16		15257,00	255701,60	1988,60 1832,00	6392,50 6392,50	±1,264
			UL121	120x16		24279,00	901522,00	2889,10 2889,10	15022,10 15022,10	±1,96
		L	L40	40x40		90645,00	90645,00	4532,20 4532,20	4532,20 4532,20	±1,759
			LX400	40x40		94881,00	94881,00	4744,10 4744,10	4744,10 4744,10	±1,802
			L41	40x40 1N		90865,00	94773,00	4543,30 4543,30	4815,40 4664,30	±1,787
			LX41	40x40 1N		95189,00	101806,00	4759,50 4759,50	5233,60 4954,60	±1,861
			L41 XMS	40x40 1N		83433,00	86102,00	4289,80 4059,80	4305,10 4305,10	±1,665
			L411 XMS	40x40		88136,00	96603,00	4481,00 4335,00	5218,50 4495,60	±1,909
			L412 XMS	40x40 2N-90°		87573,00	87573,00	4386,50 4370,80	4386,50 4370,80	±1,651
			L413	40x40x40 120°		106649,00	106638,00	5332,50 3920,90	4004,10 4004,10	±1,789
			L42	40x40 2N-180°		90958,00	100129,00	4547,90 4547,90	4979,60 5033,60	±1,827
LX42	40x40 2N-180°			95582,00	109228,00	4779,10 4779,10	5461,40 5461,40	±1,914		

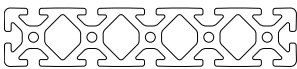
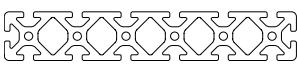

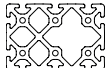
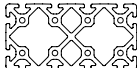

N	R	A	Typ	Abmessung B x H mm	Querschnitt	IX mm ⁴	IY mm ⁴	WX max WX min mm ³	WY max WY min mm ³	Gewicht kg/m
8	40	L	L43	40x40 2N-90°		94968,00	94968,00	4823,60 4675,60	4823,60 4675,60	±1,815
			LX43	40x40 2N-90°		102204,00	102204,00	5250,00 4977,70	5250,00 4977,70	±1,914
			L46	40x40 3N		98243,00	105184,00	4783,60 5047,80	5259,20 5259,20	±1,907
			LX46	40x40 3N		102597,00	109614,00	5266,30 5000,30	5480,70 5480,70	±1,967
			L47	40x40 4N		105696,00	105485,00	5284,80 5284,80	5274,20 5274,20	±1,961
			LX470	40x40 4N		106462,00	106462,00	5339,60 5306,70	5339,60 5306,70	±1,958
			LX470 Typ A	40x40 4N		110036,00	110036,00	5501,80 5501,80	5501,80 5501,80	±2,021
			L432	40x32		50292,00	70070,00	3148,30 3138,30	3503,50 3503,50	±1,342
			L81	80x40		171398,00	700383,00	8569,50 8569,50	17509,90 17509,90	±3,133
			LX810	80x40		169358,00	718267,00	8467,90 8467,90	17956,70 17956,70	±3,031
			L82	80x40 4N-180°		200373,00	733095,00	10018,00 10018,00	18327,00 18327,00	±3,345
			LX82	80x40 4N-180°		198602,00	751329,00	9930,10 9930,10	18783,20 18783,20	±3,257
			L83	80x40 2N		185051,00	716264,00	9555,90 8967,90	17906,60 17906,60	±3,235
			LX830	80x40 2N		189034,00	731332,00	9756,00 9165,80	18285,60 18280,90	±3,264
			L84	80x40 1N		171273,00	729052,00	8563,30 8563,30	18533,70 17928,50	±3,187
			LX84	80x40 1N		169595,00	747828,00	8479,80 8479,80	19022,60 18379,80	±3,094
			L84 XMS	80x40 1N		184593,00	755272,00	9229,60 9229,60	19115,30 18653,90	±3,518
			L841 XMS	80x40 2N-2T		175649,00	703808,00	9492,60 8171,40	17597,60 17593,50	±2,946
			L842 XMS	80x40 2N-2T		169588,00	685684,00	9280,00 7825,90	17155,50 17140,40	±2,922
			L843 XMS	80x80 2N K15		1156783,00	1295428,00	29561,70 28301,00	32386,30 32386,30	±4,976
			L89	80x40 2N-180°		172942,00	761755,00	8647,10 8647,10	19043,90 19043,90	±3,262
			LX89	80x40 2N-180°		169994,00	779091,00	8499,70 8499,70	19477,30 19477,30	±3,148
			L87	80x40 3N-90°		187125,00	747080,00	9650,70 9042,20	18947,50 18414,10	±3,324
LX87	80x40 3N-90°		183799,00	764688,00	9498,40 8900,90	19440,00 18805,00	±3,203			

N	R	A	Typ	Abmessung B x H mm	Querschnitt	IX mm ⁴	IY mm ⁴	WX max WX min mm ³	WY max WY min mm ³	Gewicht kg/m
8	40	L	L161	160x40		309544,00	4968944,00	15477,00 15477,00	62112,00 62112,00	±5,567
			LX161	160x40		315699,00	5054116,00	15723,20 15713,50	63101,40 63098,40	±5,613
			L164	160x40 4N		335787,00	5118689,00	17349,70 16264,00	63983,60 63983,60	±5,766
			L121	120x40		236578,00	2199181,00	11829,00 11829,00	36653,00 36653,00	±4,297
			LX1210	120x40		240512,00	2233237,00	12026,50 12026,50	37217,00 37217,00	±4,325
			L123	120x40 3N		256308,00	2259973,00	13231,30 12424,80	37666,20 37666,20	±4,43
			L871	80x40 6N		193777,00	769607,00	9723,90 9654,00	19275,90 19204,50	±3,354
			LX871	80x40 6N		191823,00	787516,00	9626,80 9555,70	19725,50 19650,40	±3,264
			LX871 Typ A	80x40 6N		198901,00	811034,00	9945,10 9945,10	20275,90 20275,90	±3,359
			L872	80x40 4N		187367,00	775185,00	9658,80 9094,80	19379,60 19379,60	±3,372
			L873	80x40		652826,00	77906,00	16320,70 16320,70	4101,00 3709,30	±2,183
			L874	80x40		696043,00	118969,00	17401,10 17401,10	6993,90 5174,90	±2,802
			L875	80x40		47280,00	640,00	1586,60 1586,60	352,80 72,00	±0,368
			L832	80x32		94961,00	535227,00	5983,60 5887,30	13380,70 13380,70	±2,367
			L80	80x80		1353229,00	1353229,00	33830,70 33830,70	33830,70 33830,70	±5,375
			LX800	80x80		1371439,00	1371439,00	34286,00 34286,00	34286,00 34286,00	±5,408
			L85	80x80 2N		1402860,00	1364071,00	35662,80 34499,50	34101,80 34101,80	±5,455
			L85 XMS	80x80 2N XMS		1375591,00	1366883,00	34491,00 34289,20	34724,50 33637,00	±5,466
			L86	80x80 4N-90°		1416558,00	1416558,00	36001,10 34845,60	36001,10 34845,60	±5,545
			L86 XMS	80x80 4N-90°		1416175,00	1416175,00	35593,30 35217,50	35593,30 35217,50	±5,588
			L870 Typ A	80x80 8N		1466775,00	1466775,00	36596,20 36348,40	36752,10 36588,90	±5,685
			LX880	80x80		725088,00	725088,00	17752,00 17752,00	17752,00 17752,00	±3,739
			L122	120x80		2017755,00	4209190,00	50443,90 50443,90	68280,30 72131,70	±8,102
			LX122	120x80		2024384,00	4226759,00	50609,60 50609,60	72434,30 68563,90	±8,106



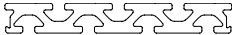

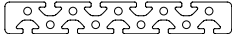
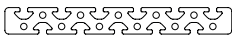

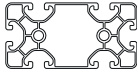
N	R	A	Typ	Abmessung B x H mm	Querschnitt	IX mm ⁴	IY mm ⁴	WX max WX min mm ³	WY max WY min mm ³	Gewicht kg/m
8	40	L	LX870	80x80 8N		1485493,00	1485493,00	37218,40 37056,80	37218,40 37056,70	±5,719
			L162	160x80		2666203,40	9063629,70	66655,10 66655,10	113295,40 113295,40	±10,153
			LX162	160x80		2670598,00	9090337,00	66764,90 66764,90	113629,20 113629,20	±10,141
			L163	160x80 4N		2778475,00	9241488,00	70749,60 68185,80	115488,90 115488,90	±10,382
			L44	40x40 R40		67027,00	67027,00	3748,20 3030,50	3748,20 3030,50	±1,545
			L441	40x40 R40		67157,00	67158,00	3838,30 2991,30	3836,70 2992,40	±1,485
			L45	40x40 G45°		66049,00	66049,00	3763,00 2942,00	3763,00 2942,00	±1,518
			L88	80x80 45°		794852,00	1110256,00	24457,20 20471,10	30621,20 25381,70	±5,13
			L884	80x80 4N-45°		1158383,00	1158383,00	32417,60 26168,20	32417,60 26168,20	±5,332
			L49	40x80x80		955309,00	955309,00	28423,30 20593,10	28423,30 20593,10	±4,797
			L494	40x80x80 4N-90°		1082289,00	1014172,00	31888,20 25497,40	30642,40 23662,70	±5,017
			L430	40x38 R40/80-30°		56345,00	69951,00	3575,70 2479,40	3059,70 3317,50	±1,436
			L445	50x45 R40/80-45°		223057,00	165253,00	9624,90 7044,90	6322,60 6901,20	±2,755
			L460	40x68 R40/80-60°		326157,00	196230,00	11144,20 8480,50	6692,90 6719,60	±2,195
			L490	40x80 R40/80-90°		693334,00	693334,00	17632,80 17088,10	17632,80 17088,10	±3,444
			LZ81	80x60		377004,00	613737,00	13041,70 12125,30	15507,40 15182,80	±2,71
			LZ61	60x40		83030,00	212394,00	4672,40 3807,60	7090,40 7090,40	±1,6941
			LZ40	40x40		81645,00	74776,00	4234,00 3940,90	3762,60 3715,20	±1,286
			KL40 CNC	40x40		96491,30	109002,50	4988,70 4970,80	5535,00 5448,20	±1,898
			KL41 CNC	40x40		107317,00	125238,00	5339,20 5339,20	6453,60 6171,10	±2,078
			KL400	18,75x11,5		1211,10	2803,20	286,80 166,40	447,20 224,50	±0,284
			KL32	32x18		16765,00	10699,00	1032,30 1032,30	1188,80 1188,80	±0,634
			L48	40x26		57641,00	26262,00	2882,10 2882,10	2020,20 2020,20	±1,202
LX4045 K15 XMS	85x60		14319487,00	623548,00	582093,00 401226,10	13810,60 13810,60	±2,929			

N	R	A	Typ	Abmessung B x H mm	Querschnitt	IX mm ⁴	IY mm ⁴	WX max WX min mm ³	WY max WY min mm ³	Gewicht kg/m
8	40	L	LX8045 K56 XMS	114x140		1038051,00	4216812,00	22239,70 15387,30	54833,40 54833,40	±6,599
			LX120 K56	120x120		4168224,00	4168157,00	77024,40 63264,70	77017,70 63264,70	±6,736
			L160	160x160		23937976,00	23937976,00	299224,70 299224,70	299224,70 299224,70	±20,793
			L169	160x16		38030,00	3099220,00	4237,70 5413,30	38740,20 38740,20	±3,784
			LF6040	60x40 Führung		96218,00	240805,00	5959,70 4033,40	7005,60 7005,60	±1,933
			LF4020	40x20 Führung		11775,00	53191,00	1320,90 1062,20	2552,80 2552,80	±0,905
			LF6740	67x40 Führung		120901,00	295361,00	5690,60 5690,60	9816,40 8001,90	±1,852
			4020U	40x17 Kabelkanal		2918,00	23327,00	577,60 244,30	1166,40 1166,40	±0,307
			40D	40x9,5 K.kanal Deckel		n.e.	n.e.	n.e. n.e.	n.e. n.e.	±0,296
			4040U	41,5x37 Kabelkanal		n.e.	n.e.	n.e. n.e.	n.e. n.e.	±0,605
			80D	80x9,5 K.kanal Deckel		n.e.	n.e.	n.e. n.e.	n.e. n.e.	±0,534
			8080U	82x77 Kabelkanal		n.e.	n.e.	n.e. n.e.	n.e. n.e.	±1,659
			8040U	82x37 Kabelkanal		n.e.	n.e.	n.e. n.e.	n.e. n.e.	±0,93
			Flex1	34x11,9 Kabelkanal		6603,00	688,00	463,40 334,30	174,90 86,30	±0,207
			Flex2	74x12 Kabelkanal		96141,00	1100,00	2787,40 2433,40	450,90 115,10	±0,553
			Flex3	114x12 Kabelkanal		346677,00	1247,00	6391,80 5801,00	607,20 125,40	±0,823
			Flex4	154x12 Kabelkanal		845326,00	1364,00	11436,90 10555,00	731,20 134,60	±1,096
			Flex5	40x16,5 Kabelkanal		5633,00	25621,00	771,10 612,50	1280,60 1280,60	±0,575
			Flex6	80x16,5 Kabelkanal		11348,00	220867,00	1560,00 1230,10	5522,20 5522,20	±1,107
			Flex7	120x16,5 Kabelkanal		17071,00	743184,00	2350,60 1848,00	12388,10 12388,10	±1,639
			Flex8	160x16,5 Kabelkanal		22779,00	1748312,00	3138,10 2464,90	21856,70 21856,70	±2,170
			Flex9	40x16,5 Kabelkanal		3327,00	23514,00	653,20 291,60	1175,70 1175,70	±0,465
Flex10	80x16,5 Kabelkanal		4310,00	177004,00	1171,10 336,20	4425,10 4425,10	±0,736			
Flex11	120x16,5 Kabelkanal		4791,00	547983,00	1582,60 395,70	9133,00 9133,00	±1,006			

N	R	A	Typ	Abmessung B x H mm	Querschnitt	IX mm ⁴	IY mm ⁴	WX max WX min mm ³	WY max WY min mm ³	Gewicht kg/m
8	40	L	Flex12	160x16,5 Kabelkanal		5090,00	1215440,00	1919,50 367,60	15193,00 15193,00	±1,276
			Flex13	80x57 Kabelkanal		111306,00	227041,00	3022,10 3022,10	6502,20 5036,10	±0,941
			Flex14	160x49,5 Kabelkanal		99099,00	1128698,00	3238,30 3238,30	14908,70 13390,20	±1,171
			VP40 CNC	57x37 Verbinder		57015,00	189084,00	3261,60 2921,00	6634,50 6634,50	±2,258
			VP41	32x6,6 V. Deckel		99,00	4879,00	18,20 18,20	304,80 304,80	±0,134
			RS40	40x40		57104,00	100968,00	3890,30 2255,20	5048,40 5048,40	±1,28
			W1	17,7		7598,00	2331,00	789,80 424,90	396,90 223,00	±0,323
		M	M121	120x40		295790,00	2368078,00	14789,50 14789,50	39468,00 39468,00	±5,139
		S	S40	40x40		141146,00	141146,00	7057,30 7057,30	7057,30 7057,30	±2,508
			S81	80x40		270249,00	1020904,00	13512,50 13512,50	25522,60 25522,60	±4,547
			S121	120x40		399848,00	3246544,00	19992,00 19992,00	54109,00 54109,00	±6,606
			S161	160x40		529199,00	7421898,00	26460,00 26460,00	92773,00 92773,00	±8,655
			S201	200x40		658855,00	14158278,00	32942,80 32942,80	141582,80 141582,80	±10,702
			S241	240x40		788233,00	24049308,00	39411,60 39411,60	200410,90 200410,90	±12,750
			KL810	13x18,2		1914,00	1124,00	216,60 204,40	172,90 172,90	±0,2
			KL814	D14		3287,20	3105,10	303,20 297,40	352,90 352,90	±0,28
			S80	80x80		1879946,00	1879946,00	46998,60 46998,60	46998,60 46998,60	±7,187
			S80D40	80x80 D40		2248720,00	2248720,00	56218,00 56218,00	56218,00 56218,00	±10,104
			S122	120x80		2711870,00	5689943,00	67796,80 67796,80	91762,20 98115,20	±10,653
			S162	160x80		3543651,70	12046081,20	88591,30 88591,30	150576,00 150576,00	±13,173
			S202	200x80		4329713,00	22035968,00	108242,80 108242,80	220359,70 220359,70	±15,170
			S45	40x40 G45°		95427,90	95427,90	5644,40 5644,40	5644,40 5644,40	±2,012
			S49	40x16		10942,30	69679,80	1276,60 1472,90	3483,90 3483,90	±1,178
S89	80x16			22058,00	496475,00	3001,70 2549,50	12411,90 12411,90	±2,196		

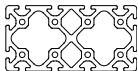
N	R	A	Typ	Abmessung B x H mm	Querschnitt	IX mm ⁴	IY mm ⁴	WX max WX min mm ³	WY max WY min mm ³	Gewicht kg/m
8	40	S	S120	120x120		7989706,00	7989706,00	133161,80 133161,80	133161,80 133161,80	±12,427
			S152	152x20		75647,90	3540133,80	7797,30 7345,80	46586,60 46574,80	±5,027
			S153	20 Verbinder		22514,20	114198,30	2457,40 2077,30	4198,40 4198,40	±1,592
			S168	160x28		208024,00	7316287,00	15188,50 14543,20	91453,60 91453,60	±8,49
			S208	200x28		257820,00	13932033,00	18744,90 18097,30	139320,30 139320,30	±10,454
			S248	240x28		307936,00	23645122,00	22300,20 21652,10	197042,70 197042,70	±12,72
	45	UL	UL45	45x45		103642,00	103642,00	4606,50 4606,50	4606,50 4606,50	±1,440
			UL91	90x45		189049,00	746605,00	8402,40 8401,90	16591,80 16590,70	±2,233

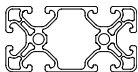
ISP 10

N	R	A	Typ	Abmessung B x H mm	Querschnitt	IX mm ⁴	IY mm ⁴	WX max WX min mm ³	WY max WY min mm ³	Gewicht kg/m
10	50	L	L50	50x50		312702,00	312702,00	12508,10 12508,10	12508,10 12508,10	±3,673
			L101	100x50		625124,00	2317885,00	25005,00 25005,00	46357,70 46357,70	±6,804
			L100A	100x100		4508170,00	4508170,00	90163,40 90163,40	90163,40 90163,40	±10,944
			L201A	200x100		8603257,00	29197498,00	172065,10 172065,10	291975,00 291975,00	±20,317
		W1	22		16848,00	7589,00	1417,50 768,80	545,90 369,50	±0,493	
		UL	UL50	50x50		207124,00	207124,00	8285,00 8285,00	8285,00 8285,00	±2,384
			UL101	100x50		370737,00	1473017,00	14829,50 14829,50	29460,30 29460,30	±3,747
			UL100	100x100		2476804,00	2476804,00	49538,30 49533,90	49534,40 49532,50	±6,151
UL59	50x20			17632,00	90769,00	1780,40 1746,30	3630,80 3630,80	±1,014		

Legende

N = Nut	R = Raster	A = Ausführung	S = schwer	Z = Zubehör
UL = ultraleicht/eco	L = leicht	M = medium	NAD = Nutabdeckprofil	
Ix/Iy = Flächenträgheitsmoment	ISPKK - D = Deckel	D = Durchmesser		
Wx/Wy = Widerstandsmoment	ISPKK - U = U-Profil			

Mechanische Eigenschaften

Bezeichnung	EN 572-3	EN AW-6063
Zustand	EN 515	T66
R _{p0,2}	[N/mm ²]	≥200
R _m	[N/mm ²]	≥245
A	[%]	≥8
A 50	[%]	≥6
Härte	[HB]	≥80

Kernbohrung

Nut 5 = 4,3+0,1/-0,2 mm	Nut 8 = 6,8+0,1/-0,2 mm
Nut 6 = 5,0+0,1/-0,2 mm	Nut 10 = 8,5+0,1/-0,2 mm

Nutmaße

Nut 5 = 5,0+0,3 mm	Nut 8 = 8,0+0,4 mm
Nut 6 = 6,2+0,3 mm	Nut 10 = 10,0+0,4 mm

Oberfläche	Eloxal E6Ev1 (silber) / E6Ev6 (schwarz) Andere Ausführungen auf Anfrage
Länge	6030-0+10 mm Kontaktstellen entfernt 6090-0+10 mm Standardkontaktierung andere Längen auf Anfrage
Normen	DIN EN 573, 755, Toleranzen DIN EN 12020



No Name Konstruktion®

ARBEITSKARTE

CSP-SYSTEM

Für Anschläge und Führungsschienen

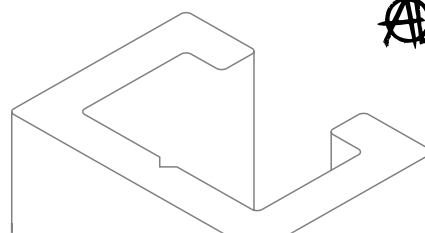

CSP

N	R	A	Typ	Abmessung B x H mm	Querschnitt	IX mm ⁴	IY mm ⁴	WX max WX min mm ³	WY max WY min mm ³	Gewicht kg/m
6	-	-	CSP 6	14x10		690,0	1618,0	163,1 119,5	231,1 231,1	±0,163
8	-	-	CSP 8	17x11		1017,0	2874,0	224,3 157,4	338,1 338,1	±0,191
10	-	-	CSP 10	22x13		2291,0	7518,0	425,4 301,0	683,5 683,5	±0,307

Legende

Mechanische Eigenschaften

Bezeichnung	EN 572-3	EN AW-6063
Zustand	EN 515	T66
R _p 0,2	[N/mm ²]	≥200
R _m	[N/mm ²]	≥245
A	[%]	≥8
A 50	[%]	≥6
Härte	[HB]	≥80

N = Nut
R = Raster
A = Ausführung

I_x/I_y = Flächenträgheitsmoment
W_x/W_y = Widerstandsmoment

Oberfläche	Eloxal E6Ev1 (silber) Andere Ausführungen auf Anfrage
Länge	6090-0+10 mm Standardkontaktierung Andere Längen auf Anfrage
Normen	DIN EN 573, 755, Toleranzen DIN EN 12020



No Name Konstruktion®

ARBEITSKARTE

VSP-SYSTEM

OpenBuilds kompatibel

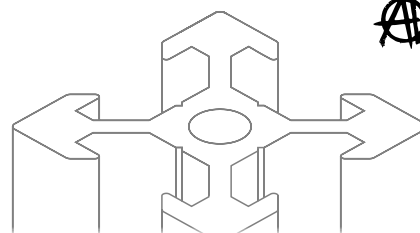

VSP

N	R	A	Typ	Abmessung B x H mm	Querschnitt	IX mm ⁴	IY mm ⁴	WX max WX min mm ³	WY max WY min mm ³	Gewicht kg/m
6	20	L	L20	20x20		7036,0	7036,0	704,0 703,8	704,0 703,8	±0,466
			L40	40x40		83941,0	83941,0	4198,0 4196,0	4198,0 4196,0	±1,283
			L41	40x20		12390,0	48403,0	1239,4 1238,7	2421,1 2419,3	±0,815
			L61	60x20		17744,0	149918,0	1774,7 1774,1	4998,8 4995,8	±1,164
			L81	80x20		23098,0	337311,0	2310,1 2309,4	8434,8 8430,7	±1,512
			L840	40x80x40		121561,0	583424,0	6995,8 5373,2	14586,2 14585,1	±2,231

Legende

Mechanische Eigenschaften

Bezeichnung	EN 572-3	EN AW-6063
Zustand	EN 515	T66
R _p 0,2	[N/mm ²]	≥200
R _m	[N/mm ²]	≥245
A	[%]	≥8
A 50	[%]	≥6
Härte	[HB]	≥80

Kernbohrung

4,2 +/- 0,15 mm

Nutmaße

Nut 6 = 6,0+0,3 mm

N = Nut

R = Raster

A = Ausführung

L = leicht

I_x/I_y = Flächenträgheitsmoment

W_x/W_y = Widerstandsmoment

Oberfläche	Eloxal E6Ev1 (silber) / E6Ev6 (schwarz) Andere Ausführungen auf Anfrage
Länge	6090-0+10 mm Standardkontaktierung Andere Längen auf Anfrage
Normen	DIN EN 573, 755, Toleranzen DIN EN 12020

Kontakt



Raimondo Cavallaro

PLZ 0-3

raimondo.cavallaro@mejo.de
Tel. +49 211 99890-37



Yasemin Maceiras

PLZ 4-5

yasemin.maceiras@mejo.de
Tel. +49 211 99890-32



Marco Kunze

PLZ 6-9

marco.kunze@mejo.de
Tel. +49 911 9652234-15



Björn Haist

Österreich

bjoern.haist@mejo.de
Tel. +43 1 2264 421-10



Hauptverwaltung

mejo Metall Josten GmbH & Co. KG
Bublitzer Straße 23
40599 Düsseldorf
Tel. +49 211 99890-0
info@mejo.de

Niederlassung Nürnberg

mejo Metall Josten GmbH & Co. KG
Rothenburger Straße 241
90439 Nürnberg
Tel. +49 911 9652234-11
nuernberg@mejo.de

Niederlassung Wien

mejo Aluminium GmbH
Ausstellungsstraße 50/C/2. OG
AT-1020 Wien
Tel. +43 1 2264 421-10
wien@mejo.de

Zentrallager Viersen

mejo Metall Josten GmbH & Co. KG
Gewerbering 20
41751 Viersen
Tel. +49 2162 36178-99
info@mejo.de

Verkoopkantoor Benelux

mejo Aluminium B.V.
Ravenseind 13
5571 SE Bergeijk
Tel. +31 497 2258-00
info@mejo.com

Abweichungen und Änderungen: siehe detailliertes Datenblatt und technische Zeichnung. Kernbohrungen vorgesehen für Gewindeschneiden und entsprechende Schnellspanverbinder. Der Einsatz gewindefurchender bzw. gewindeschneidender Schrauben ist im Vorfeld zu prüfen. Irrtümer vorbehalten. Alle Angaben und technische Daten ohne Gewähr und vorbehaltlich der Eignung für den vorgesehenen Verwendungszweck. Angegebene Gewichte sind theoretisch ermittelt. Maßgebend für die Fakturierung ist das tatsächliche Liefergewicht. Für unrichtige Angaben (z. B. Druckfehlern) übernehmen wir keine Haftung. Für Lieferungen gelten unsere Verkaufs-, Lieferungs- und Zahlungsbedingungen. Die neueste Fassung senden wir Ihnen gerne zu.